

Submersible Dewatering Pumps





Dewatering Solutions for the Real World

In the real world time is money, and worksites have no time for unwanted water. Sulzer has the solutions in a complete pump range for reliable dewatering.

This brochure is an overview of Sulzer's submersible dewatering pumps, which are the result of more than 50 years of technical and real-world experience. Each pump type is presented with its key features, as well as dimensions, performance curves and the most important technical data for specific pump models.

Whether you work in mining, tunneling or construction, the pumps here are your best insurance against water-related downtime. From purchasing to service, you can turn to Sulzer for dewatering solutions that make a difference in the real world.

CONTENT	PAGE
Dewatering Solutions for the Real World	3
Submersible Drainage Pumps	
J (small)	4-5
XJ (medium)	6-7
J (large)	8-9
Submersible Drainage Center-Line Pumps	
JC and XJC	10-11
Submersible Sludge Pumps	
JS	12-13
XJS	14-15
AquaTronic and Other Supervision Options	16
Overview of Electronic Supervision Features	17
Pump Options and Accessories	18-19

Performance range 50 Hz

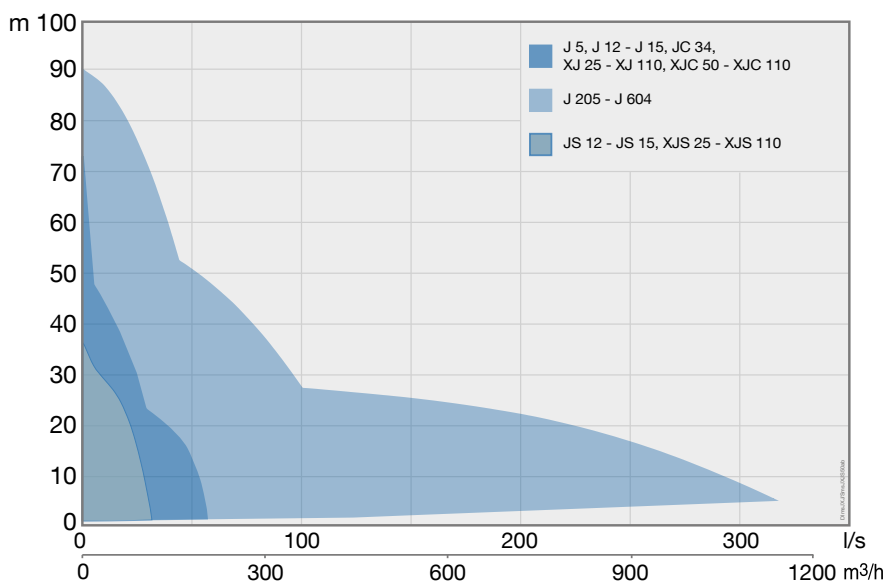

Sulzer's complete range of submersible dewatering pumps provides reliable solutions for all major dewatering needs.

Submersible Drainage Pump J

Submersible drainage pump J is suitable for pumping water and dirty water mixed with light abrasives. The low weight and compact design makes for convenient transport, handling and installation.

1 Easy start

A built-in contactor connected to the thermal sensors in the stator windings protects the motor from overheating and features an automatic restart function.

2 Wear resistance

An impeller in white cast iron with a full upper shroud and adjustable wear parts coated in nitrile rubber ensure high abrasion resistance.

3 Reliable operation

A double mechanical shaft seal in an oil bath, with primary and secondary seal surfaces in silicon carbide, extends the life of the pump. A double outer casing and good heat convection enable the pump to operate continuously at low levels – or even run dry without damaging the motor.

4 Serviceability

Due to the modular design, the same parts can be used for different pumps, which lowers the overall service costs. An adjustable diffuser ensures proper clearance throughout the impeller lifetime. By removing the top cover of the pump, the electrical junction area can easily be checked.

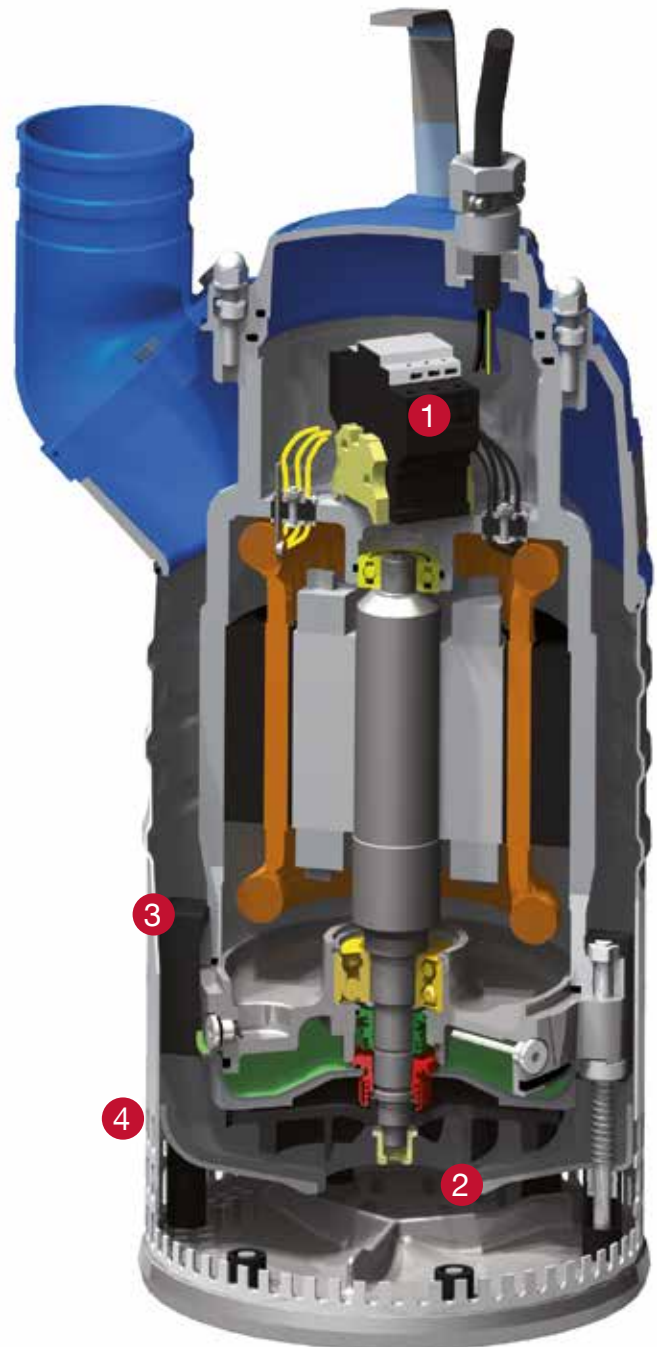

SUBMERSIBLE DRAINAGE PUMP J 5

J 5 W

1-PHASE

Motor rating P2	0.48 kW, 1~
Voltage (V)	230
Full load (A)	2.9
Speed	2690 rpm
Strainer hole	6 mm
Discharge connections	Hose 2" Thread G/BSP 2"
Weight (excl. cable)	9.5 kg
Motor protection	Built-in
Electric cable	10 m

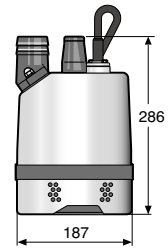
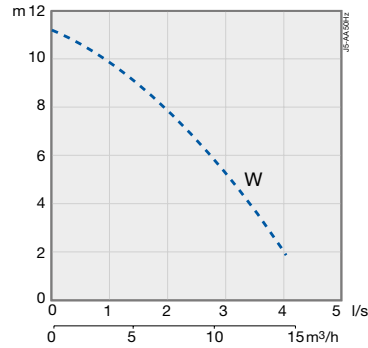

SUBMERSIBLE DRAINAGE PUMP J 12

J 12 W/J 12 WKS* J 12 D/J 12 DKS**

1-PHASE

3-PHASE

Motor rating P2	0.9 kW, 1~	1 kW, 3~
Voltage (V)	110 / 230	230 / 400 / 500
Full load (A)	10.9 / 5.2	4.0 / 2.3 / 1.9
Speed	2750 rpm	2800 rpm
Strainer hole	6.5 x 22 mm	
Discharge connections	Hose 1½", 2", 2½", 3" Thread G/BSP 2", 2½", 3"	
Weight (excl. cable)	16 kg	
Motor protection	Built-in	
Electric cable	20 m	

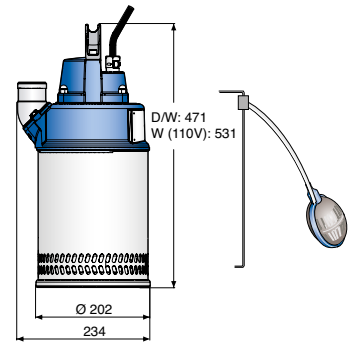
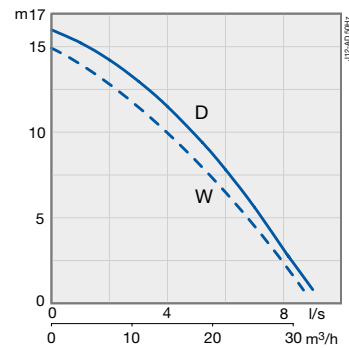

SUBMERSIBLE DRAINAGE PUMP J 15

J 15 W/J 15 WKS* J 15 D/J 15 DKS**

1-PHASE

3-PHASE

Motor rating P2	1.4 kW, 1~	1.4 kW, 3~
Voltage (V)	230	230 / 400 / 500
Full load (A)	8.1	5.0 / 2.9 / 2.3
Speed	2800 rpm	2800 rpm
Strainer hole	6.5 x 22 mm	
Discharge connections	Hose 1½", 2", 2½", 3" Thread G/BSP 2", 2½", 3"	
Weight (excl. cable)	18 kg (W), 16.5 kg (D)	
Motor protection	Built-in	
Electric cable	20 m	

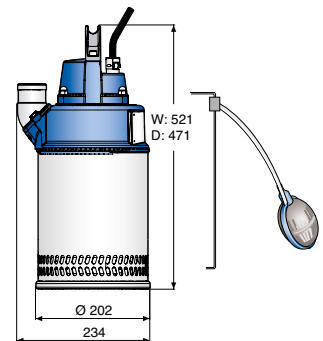
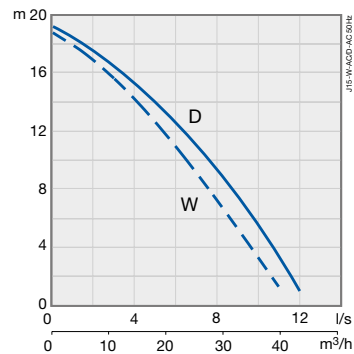

* Built-in float switch available as option.

** KS version not available in 500 V.

Submersible Drainage Pump XJ

Submersible drainage pump XJ is excellent for pumping water and dirty water mixed with light abrasives. The slim design makes the pump easy to move and easy to handle.

1 Easy and fail-safe starting

Instead of a built-in contactor, an optional AquaTronic unit can be used. The AquaTronic unit compensates for incorrect phase order, which ensures correct motor rotation every time. (Additional AquaTronic functions for electronic supervision are explained on pages 16-17.)

2 Wear resistance

An impeller and wear ring in white cast iron, as well as diffusers coated in oil-resistant nitrile rubber, provide high abrasion resistance.

3 Reliable operation

Double mechanical shaft seals in an oil bath, with primary seal surfaces in silicon carbide and secondary seal surfaces in silicon carbide on carbon, extend the life of the pump. A double cable-entry seal system increases the protection against moisture entering the electrical junction area. A double outer casing and good heat convection enable the pump to operate continuously at low levels – or even run dry without damaging the motor.

4 Serviceability

Due to the modular design, the same parts can be used for different pumps, which lowers the overall service costs. The adjustable wear ring ensures proper clearance throughout the impeller lifetime. External inspection ports for the oil and motor chambers enable quick and easy evaluation of the shaft seal during service. By removing the top cover of the pump, the electrical junction area can easily be checked.

5 Less energy and environmental impact

The high-efficiency motor and new hydraulics combine with low-friction bearings to reduce power losses. The result is low total energy costs and minimized carbon footprint.

6 Flexibility

Conversion between high-volume and high-head hydraulics is managed with only a few parts, ensuring the right performance for the application.

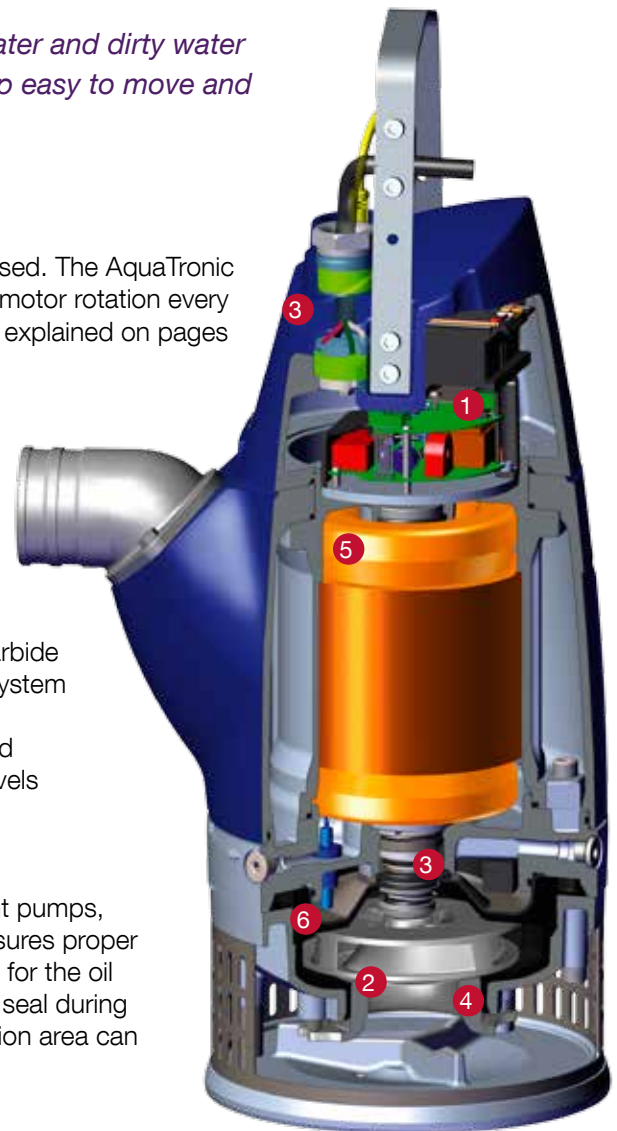

SUBMERSIBLE DRAINAGE PUMP XJ 25

XJ 25 ND*	MEDIUM HEAD
XJ 25 HD*	HIGH HEAD
Motor rating P2	2.5 kW, 3~
Voltage (V)	230 / 400 / 500-550 / 690 / 1000
Full load (A)	8.8 / 5.1 / 4.3 / 2.9 / 2.0
Speed	2920 rpm
Strainer hole	7.5 x 22 mm
Discharge connections	Hose 2½", 3", 4" Thread G/BSP 2½", 3", 4"
Weight (excl. cable)	39 kg
Motor protection	Built-in
Electric cable	20 m

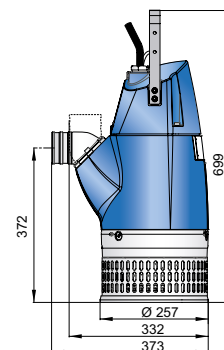
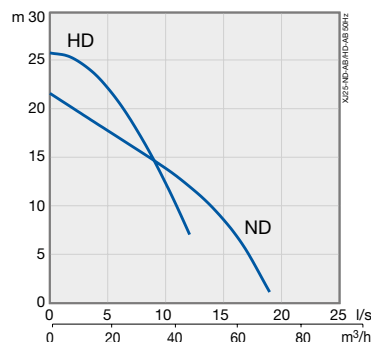

SUBMERSIBLE DRAINAGE PUMP XJ 40

XJ 40 ND*	MEDIUM HEAD
XJ 40 HD*	HIGH HEAD
Motor rating P2	3.7 kW, 3~
Voltage (V)	230 / 400 / 500-550 / 690 / 1000
Full load (A)	13.2 / 7.6 / 6.1 / 4.4 / 3.0
Speed	2860 rpm
Strainer hole	7.5 x 22 mm
Discharge connections	Hose 2½", 3", 4" Thread G/BSP 2½", 3", 4"
Weight (excl. cable)	42 kg
Motor protection	Built-in
Electric cable	20 m

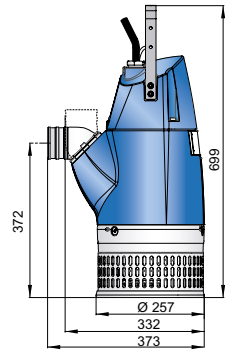
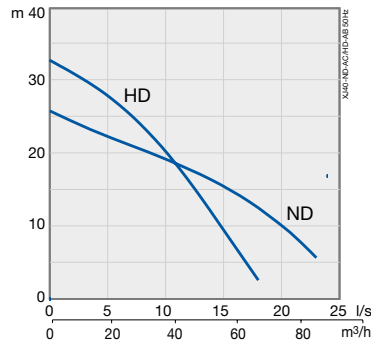

SUBMERSIBLE DRAINAGE PUMP XJ 50

XJ 50 ND*	MEDIUM HEAD
XJ 50 LD*	HIGH FLOW
XJ 50 HD*	HIGH HEAD
Motor rating P2	5.6 kW, 3~
Voltage (V)	230 / 400 / 500-550 / 690 / 1000
Full load (A)	19.7 / 11.3 / 9.0-10.8 / 6.6 / 4.5
Speed	2930 rpm
Strainer hole	7.5 x 22 mm
Discharge connections	Hose 3", 4", 6" Thread G/BSP 3", 4", 6"
Weight (excl. cable)	59 kg
Motor protection	Built-in
Electric cable	20 m

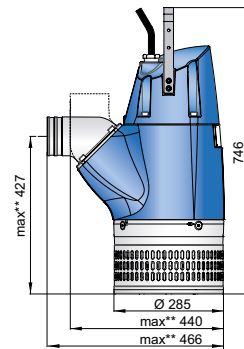
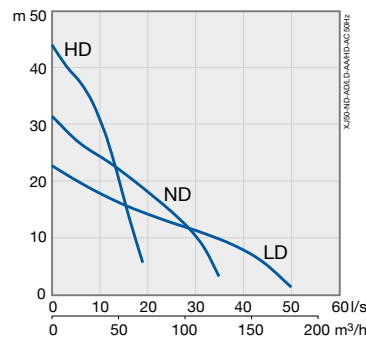

SUBMERSIBLE DRAINAGE PUMP XJ 80

XJ 80 ND*	MEDIUM HEAD
XJ 80 LD*	HIGH FLOW
XJ 80 SD*	HIGH HEAD
Motor rating P2	8.3 kW, 3~
Voltage (V)	230 / 400 / 500-550 / 690 / 1000
Full load (A)	27.8 / 16 / 13.8 / 9.3 / 6.4
Speed	2920 rpm
Strainer hole	7.5 x 22 mm
Discharge connections	Hose 3", 4", 6" Thread G/BSP 3", 4", 6"
Weight (excl. cable)	63 kg (ND/LD), 78 kg (SD)
Motor protection	Built-in
Electric cable	20 m

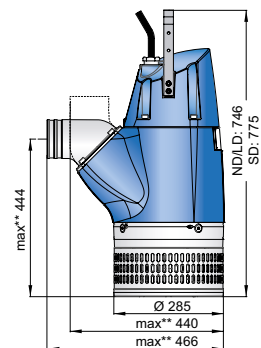
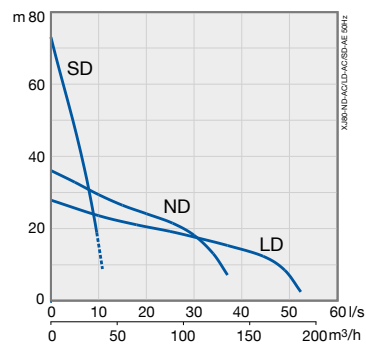

SUBMERSIBLE DRAINAGE PUMP XJ 110

XJ 110 ND*	MEDIUM HEAD
XJ 110 HD*	HIGH HEAD
Motor rating P2	11.8 kW, 3~
Voltage (V)	230 / 400 / 500-550 / 690 / 1000
Full load (A)	37.4 / 21.5 / 17.2 / 12.5 / 8.6
Speed	2920 rpm
Strainer hole	7.5 x 22 mm
Discharge connections	Hose 3", 4", 6" Thread G/BSP 3", 4", 6"
Weight (excl. cable)	81 kg
Motor protection	Built-in
Electric cable	20 m

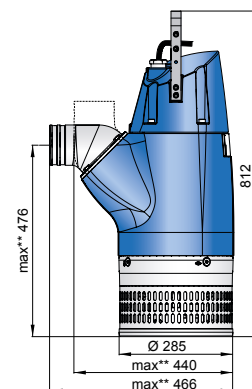
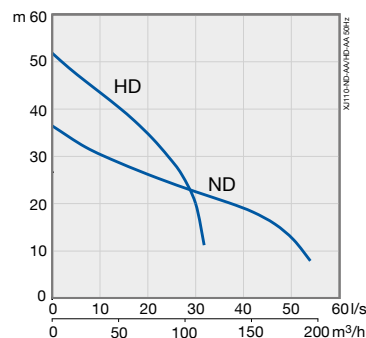

* Option: AquaTronic, built-in electronic pump control.
** Max measurement based on largest discharge size.

Submersible Drainage Pump J

Submersible drainage pump J is suitable for pumping water and dirty water mixed with light abrasives. The pump design enables convenient transport, handling and installation.

1 Easy to start

Pump J 205 has a built-in contactor connected to the thermal sensors in the stator windings, which protects the motor from overheating and features an automatic restart function. Pumps J 405 and J 604 have thermal sensors in the stator windings that protect the motor from overheating by means of an external control panel.

2 Wear resistance

Abrasive-resistant impellers, combined with diffusers and wear rings coated in oil-resistant nitrile rubber, provide extended pump life in tough applications.

3 Reliable operation

Double mechanical shaft seals in an oil bath, with primary seal surfaces in silicon carbide, extend the life of the pump. In pumps J 205 and J 405, the primary and secondary seals comprise an easy-to-replace seal cartridge. A double outer casing and good heat convection enable the pump to operate continuously at low levels – or even run dry without damaging the motor.

4 Serviceability

External inspection ports for the oil and motor chambers enable quick and easy evaluation of the shaft seal during service. By removing the top cover of the pump, the electrical junction area can easily be checked. The adjustable wear ring ensures proper clearance throughout the impeller lifetime.

5 Flexibility

Conversion between high-volume and high-head hydraulics is managed with only a few parts, ensuring the right performance for the application.

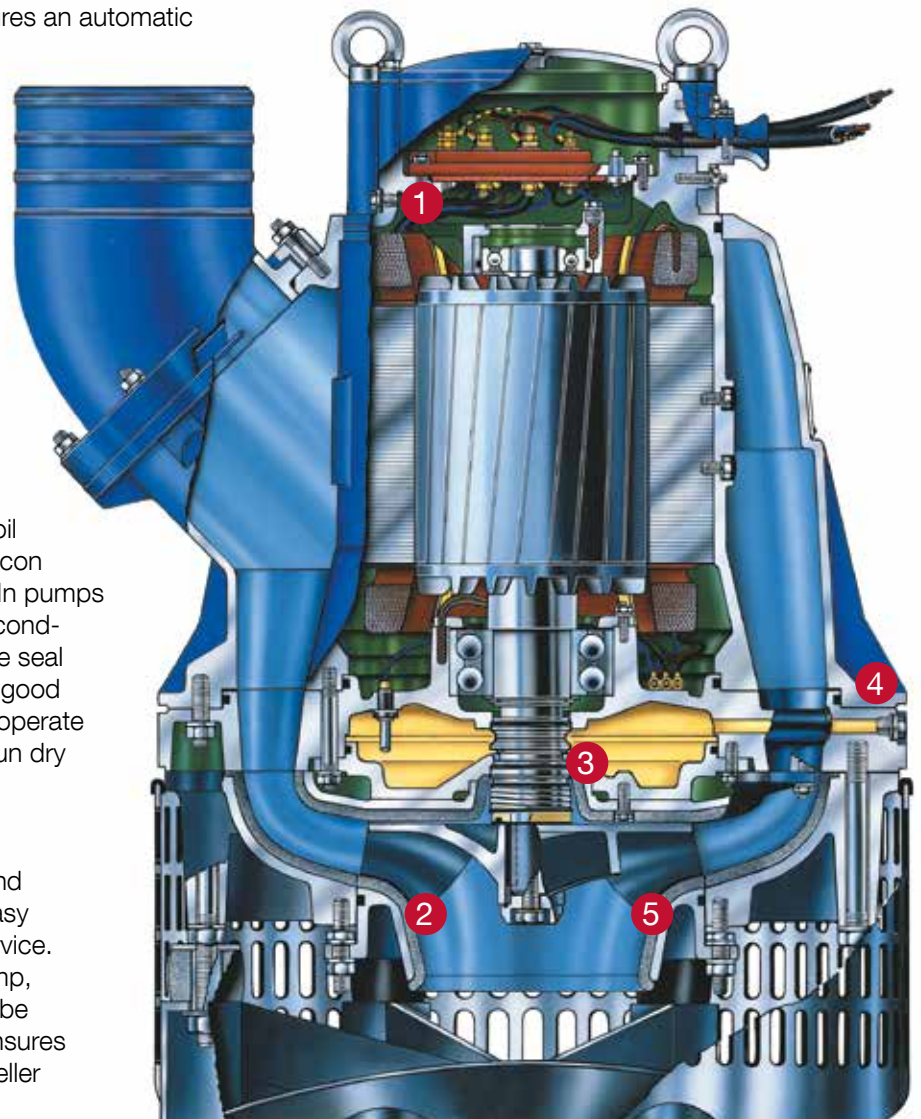

SUBMERSIBLE DRAINAGE PUMP J 205

J 205 ND	MEDIUM HEAD
J 205 HD	HIGH HEAD
Motor rating P2	21 kW, 3~
Voltage (V)	230 / 400 / 500-550 / 690 / 1000
Full load (A)	68 / 39 / 31.2 / 23 / 16
Speed	2910 rpm
Strainer hole	8 x 34 mm
Discharge connections	Hose 4", 6", 8" Thread G/BSP 4", 6", 8"
Weight (excl. cable)	155 kg
Motor protection	Built-in
Electric cable	20 m

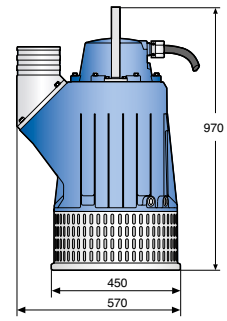
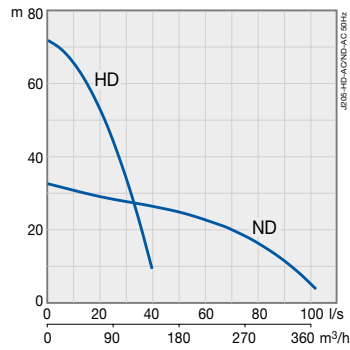

SUBMERSIBLE DRAINAGE PUMP J 405

J 405 ND	MEDIUM HEAD
J 405 HD	HIGH HEAD
Motor rating P2	35 kW, 3~
Voltage (V)	230 / 400 / 500-550 / 690 / 1000
Full load (A)	108 / 62 / 51 / 36 / 25
Speed	2930 rpm
Strainer hole	8 x 34 mm
Discharge connections	Hose 4", 6", 8" Thread G/BSP 4", 6", 8"
Weight (excl. cable)	270 kg
Motor protection	Thermal overload sensors
Electric cable	20 m

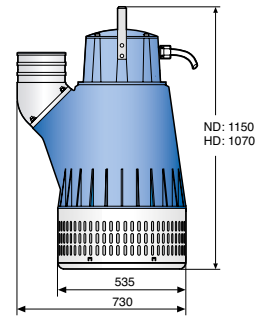
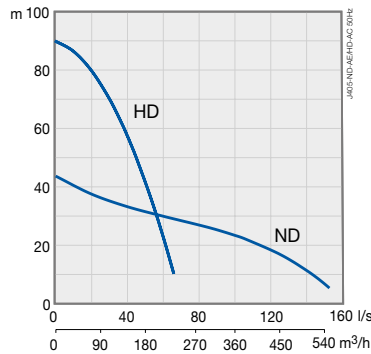

SUBMERSIBLE DRAINAGE PUMP J 604

J 604 ND	MEDIUM HEAD
J 604 HD	HIGH HEAD
Motor rating P2	56 kW, 3~
Voltage (V)	230 / 400 / 500-550 / 690 / 1000
Full load (A)	184 / 106 / 84 / 61 / 42
Speed	1450 rpm
Strainer hole	12 x 60 mm
Discharge connections	Hose 6", 8", 10" Thread G/BSP 6", 8"
Weight (excl. cable)	525 kg
Motor protection	Thermal overload sensors
Electric cable	20 m

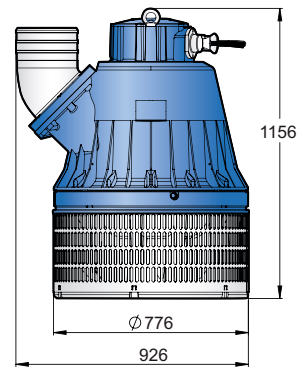
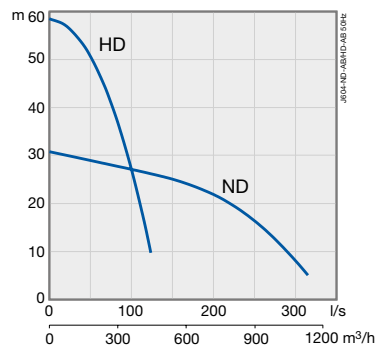

Submersible Drainage Center-Line Pumps JC and XJC

Submersible drainage center-line pumps JC and XJC are excellent for pumping water and dirty water mixed with light abrasives. The slim design makes them easy to move and easy to handle, and they are perfect for applications with limited installation space.

1 Easy and fail-safe starting

In XJC pump models, an optional AquaTronic unit can be used instead of a built-in contactor. The AquaTronic unit compensates for incorrect phase order, which ensures correct motor rotation every time. (Additional AquaTronic functions for electronic supervision are explained on pages 16-17.) In JC pump models, a built-in contactor with an automatic restart function protects the motor.

2 Wear resistance

An impeller and wear ring in white cast iron, as well as diffusers coated in oil-resistant nitrile rubber, provide high abrasion resistance.

3 Reliable operation

Double mechanical shaft seals in an oil bath, with primary seal surfaces in silicon carbide and secondary seal surfaces in silicon carbide on carbon, extend the life of the pump. Pumps XJC 50 - XJC 110 have a double cable-entry seal system that increases the protection against moisture entering the electrical junction area. A double outer casing and good heat convection enable the pump to operate continuously at low levels – or even run dry without damaging the motor.

4 Serviceability

Due to the modular design, the same parts can be used for different pumps, which lowers the overall service costs. The adjustable wear ring ensures proper clearance throughout the impeller lifetime. External inspection ports for the oil and motor chambers enable quick and easy evaluation of the shaft seal during service. By removing the top cover of the pump, the electrical junction area can easily be checked.

5 Less energy and environmental impact

Pumps XJC 50 - XJC 110 are equipped with high-efficiency motors and new hydraulics, which combine with low-friction bearings to reduce power losses. The result is low total energy costs and minimized carbon footprint.

6 Flexibility

Pumps XJC 50 - XJC 110 allow conversion between high-volume and high-head hydraulics with only a few parts, ensuring the right performance for the application.

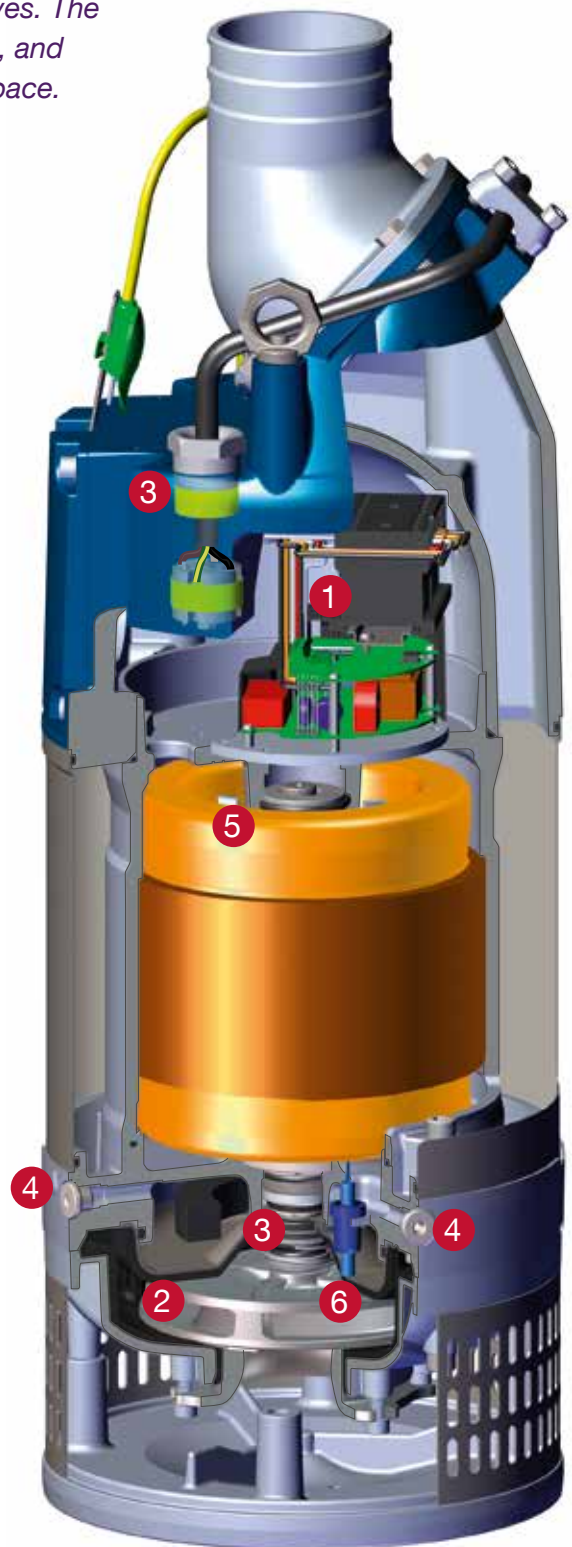

SUBMERSIBLE DRAINAGE CENTER-LINE PUMP JC 34

JC 34 ND JC 34 HD	MEDIUM HEAD HIGH HEAD
Motor rating P2	3 kW, 3~
Voltage (V)	230 / 400 / 500
Full load (A)	12.7 / 7.3 / 5.5
Speed	2850 rpm
Strainer hole	8 x 33 mm
Discharge connections	Hose 2", 3" Thread G/BSP 2", 3"
Weight (excl. cable)	31 kg
Motor protection	Built-in
Electric cable	20 m

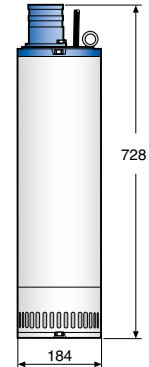
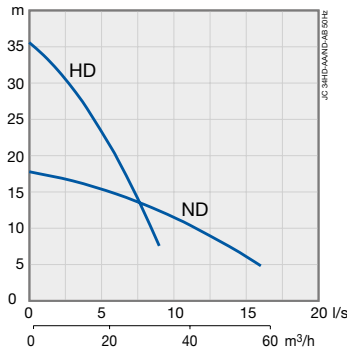

SUBMERSIBLE DRAINAGE CENTER-LINE PUMP XJC 50

XJC 50 ND* XJC 50 LD* XJC 50 HD*	MEDIUM HEAD HIGH FLOW HIGH HEAD
Motor rating P2	5.6 kW, 3~
Voltage (V)	230 / 400 / 500-550 / 690 / 1000
Full load (A)	19.7 / 11.3 / 9.0-10.8 / 6.6 / 4.5
Speed	2930 rpm
Strainer hole	7.5 x 22 mm
Discharge connections	Hose 3", 4", 6" Thread G/BSP 3", 4", 6"
Weight (excl. cable)	59 kg
Motor protection	Built-in
Electric cable	20 m

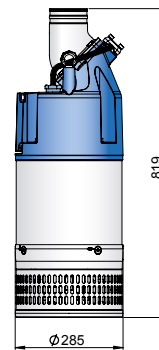
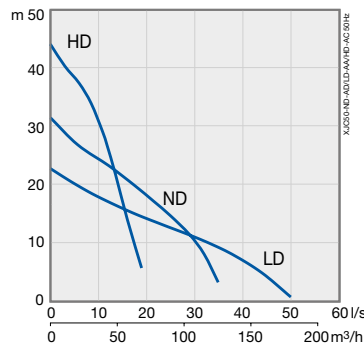

SUBMERSIBLE DRAINAGE CENTER-LINE PUMP XJC 80

XJC 80 ND* XJC 80 LD* XJC 80 SD*	MEDIUM HEAD HIGH FLOW HIGH HEAD
Motor rating P2	8.3 kW, 3~
Voltage (V)	230 / 400 / 500-550 / 690 / 1000
Full load (A)	27.8 / 16 / 13.8 / 9.3 / 6.4
Speed	2920 rpm
Strainer hole	7.5 x 22 mm
Discharge connections	Hose 3", 4", 6" Thread G/BSP 3", 4", 6"
Weight (excl. cable)	63 kg (ND/LD), 78 kg (SD)
Motor protection	Built-in
Electric cable	20 m

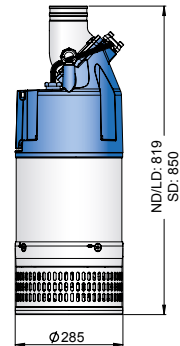
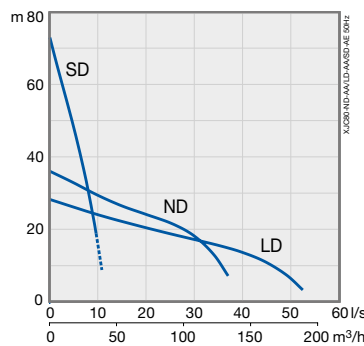

SUBMERSIBLE DRAINAGE CENTER-LINE PUMP XJC 110

XJC 110 ND* XJC 110 HD*	MEDIUM HEAD HIGH HEAD
Motor rating P2	11.8 kW, 3~
Voltage (V)	230 / 400 / 500-550 / 690 / 1000
Full load (A)	37.4 / 21.5 / 17.2 / 12.5 / 8.6
Speed	2920 rpm
Strainer hole	7.5 x 22 mm
Discharge connections	Hose 3", 4", 6" Thread G/BSP 3", 4", 6"
Weight (excl. cable)	80 kg
Motor protection	Built-in
Electric cable	20 m

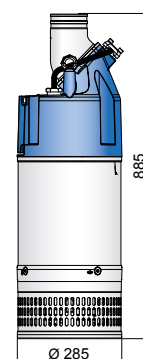
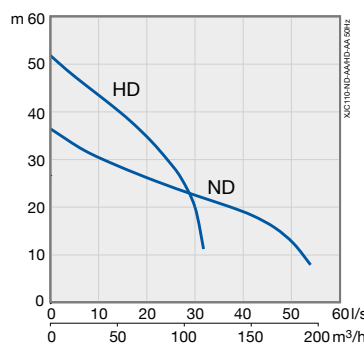

* Option: AquaTronic, built-in electronic pump control.

Submersible Sludge Pump JS

Submersible sludge pump JS is excellent for pumping dirty water and water mixed with solids. The pump has a slim design and low weight, which makes it easy to move and easy to handle.

1 Easy to start

A built-in contactor connected to the thermal sensors in the stator windings protects the motor from overheating and features an automatic restart function.

2 Clog-free pumping

A free-flow vortex impeller and pump volute make the pump ideal for pumping solids. The impeller is available in different sizes to meet specific requirements.

3 Reliable operation

Both the impeller and volute are made from heavy-duty ductile iron for maximum durability. Double mechanical shaft seals in an oil bath, with primary and secondary seal surfaces in silicon carbide, extend the life of the pump.

4 Convenient handling

The top cover and motor housing are made of light-weight aluminum, which creates a pump that is very easy to handle and install.

5 Serviceability

Due to the modular design, the same parts can be used for different pumps, which lowers the overall service costs. External inspection ports for the oil and motor chambers enable quick and easy evaluation of the shaft seal during service. By removing the top cover of the pump, the electrical junction area can easily be checked.

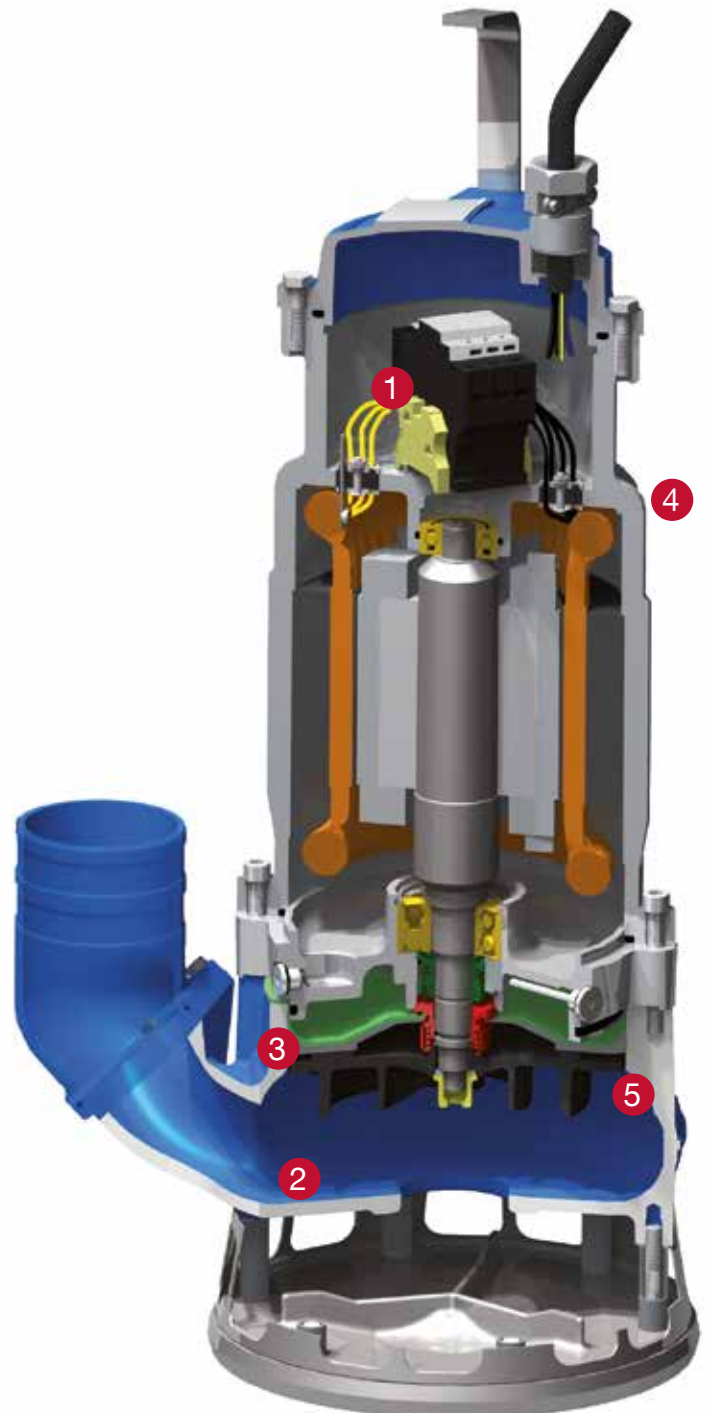

SUBMERSIBLE SLUDGE PUMP JS 12

JS 12 W/WKS* -104	1-PHASE	
JS 12 W/WKS* -114	1-PHASE	
JS 12 D/DKS* -104		3-PHASE
JS 12 D/DKS* -114		3-PHASE

Motor rating P2	0.9 kW, 1~	0.9 kW, 3~
Voltage (V)	230	230 / 400 / 500
Full load (A)	5.1	3.3 / 1.9 / 1.5
Speed	2850 rpm	2850 rpm
Free passage	45 x 40 mm	
Discharge connections	Hose 2", 2½", 3" Thread G/BSP 2", 2½", 3"	
Weight (excl. cable)	18 kg	
Motor protection	Built-in	
Electric cable	20 m	

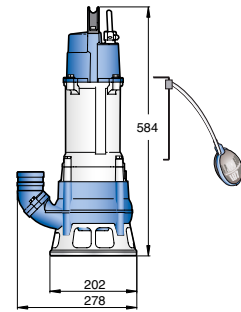
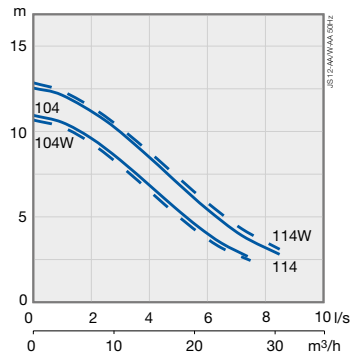

SUBMERSIBLE SLUDGE PUMP JS 15

JS 15D/DKS* -114	3-PHASE
JS 15D/DKS* -126	3-PHASE

Motor rating P2	1.3 kW, 3~
Voltage (V)	230 / 400 / 500
Full load (A)	4.5 / 2.6 / 2.1
Speed	2850 rpm
Free passage	45 x 40 mm
Discharge connections	Hose 2", 2½", 3" Thread G/BSP 2", 2½", 3"
Weight (excl. cable)	18 kg
Motor protection	Built-in
Electric cable	20 m

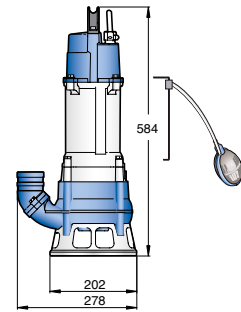
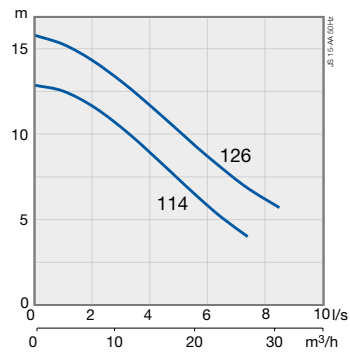

* Built-in float switch available as option. KS version not available in 500 V.



Submersible Sludge Pump XJS

Submersible sludge pump XJS is excellent for pumping dirty water and water mixed with solids. The slim design makes the pump easy to move and easy to handle.

1 Easy and fail-safe starting

Instead of a built-in contactor, an optional AquaTronic unit can be used. The AquaTronic unit compensates for incorrect phase order, which ensures correct motor rotation every time. (Additional AquaTronic functions for electronic supervision are explained on pages 16-17.)

2 Clog-free pumping

A free-flow vortex impeller and pump volute make the pump ideal for pumping solids. The impeller is available in different sizes to meet specific requirements.

3 Reliable operation

Both the impeller and volute are made from heavy-duty ductile iron for maximum durability. Double mechanical shaft seals in an oil bath, with primary seal surfaces in silicon carbide and secondary seal surfaces in silicon carbide on carbon, extend the life of the pump. A double cable-entry seal system increases the protection against moisture entering the electrical junction area.

4 Convenient handling

The top cover and motor housing are made of lightweight aluminum, which creates a pump that is very easy to handle and install.

5 Serviceability

Due to the modular design, the same parts can be used for different pumps, which lowers the overall service costs. External inspection ports for the oil and motor chambers enable quick and easy evaluation of the shaft seal during service. By removing the top cover of the pump, the electrical junction area can easily be checked.

6 Less energy and environmental impact

The high-efficiency motor and hydraulics combine with low-friction bearings to reduce power losses. The result is low total energy costs and minimized carbon footprint.

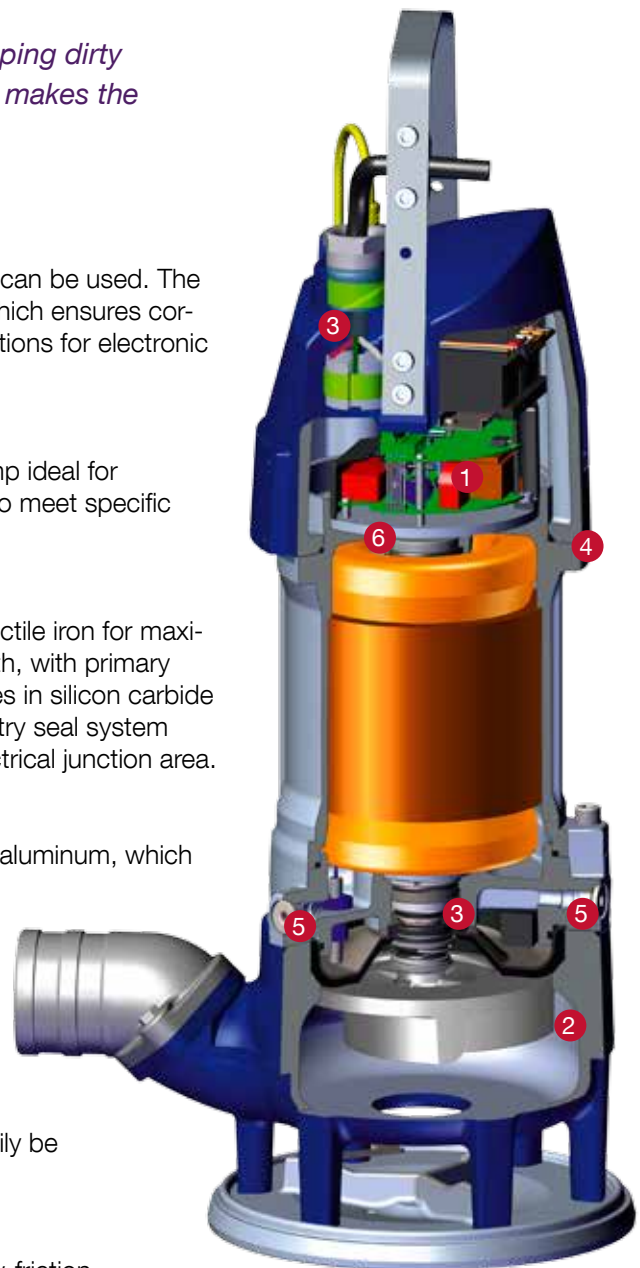

SUBMERSIBLE SLUDGE PUMP XJS 25

XJS 25 D* -128
XJS 25 D* -143

Motor rating P2	2.5 kW, 3~
Voltage (V)	230 / 400 / 500-550 / 690 / 1000
Full load (A)	8.8 / 5.1 / 4.3 / 2.9 / 2.0
Speed	2920 rpm
Free passage	45 x 55 mm
Discharge connections	Hose 2½", 3", 4" Thread G/BSP 2½", 3", 4"
Weight (excl. cable)	39 kg
Motor protection	Built-in
Electric cable	20 m

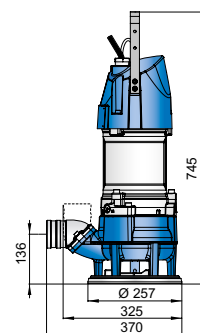
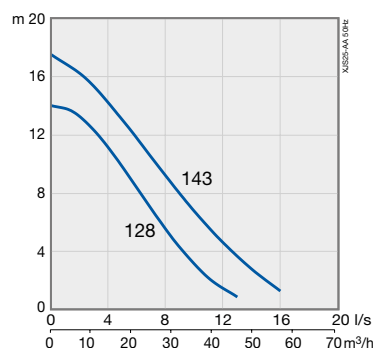

SUBMERSIBLE SLUDGE PUMP XJS 40

XJS 40 D* -143
XJS 40 D* -160

Motor rating P2	3.7 kW, 3~
Voltage (V)	230 / 400 / 500-550 / 690 / 1000
Full load (A)	13.2 / 7.6 / 6.1 / 4.4 / 3.0
Speed	2860 rpm
Free passage	45 x 55 mm
Discharge connections	Hose 2½", 3", 4" Thread G/BSP 2½", 3", 4"
Weight (excl. cable)	41 kg
Motor protection	Built-in
Electric cable	20 m

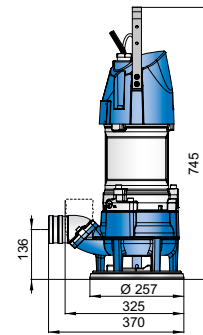
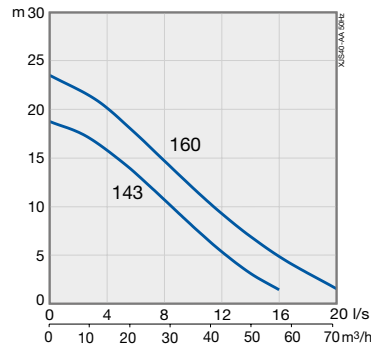

SUBMERSIBLE SLUDGE PUMP XJS 50

XJS 50 D* -160
XJS 50 D* -175

Motor rating P2	5.6 kW, 3~
Voltage (V)	230 / 400 / 500-550 / 690 / 1000
Full load (A)	19.7 / 11.3 / 9.0 / 6.6 / 4.5
Speed	2930 rpm
Free passage	48 x 60 mm
Discharge connections	Hose 2½", 3", 4" Thread G/BSP 2½", 3", 4"
Weight (excl. cable)	59 kg
Motor protection	Built-in
Electric cable	20 m

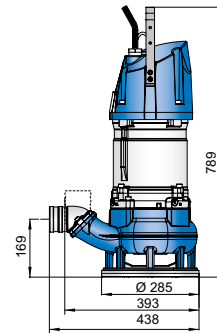
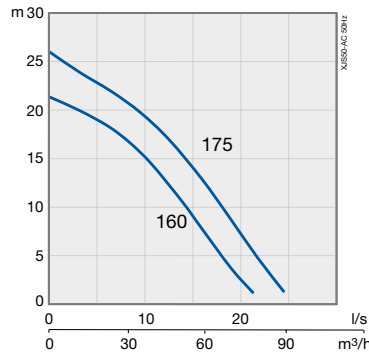

SUBMERSIBLE SLUDGE PUMP XJS 80

XJS 80 D* -175
XJS 80 D* -195

Motor rating P2	8.3 kW, 3~
Voltage (V)	230 / 400 / 500-550 / 690 / 1000
Full load (A)	27.8 / 16 / 12.8 / 9.3 / 6.4
Speed	2920 rpm
Free passage	48 x 60 mm
Discharge connections	Hose 2½", 3", 4" Thread G/BSP 2½", 3", 4"
Weight (excl. cable)	64 kg
Motor protection	Built-in
Electric cable	20 m

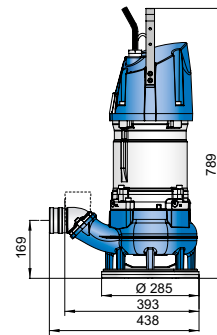
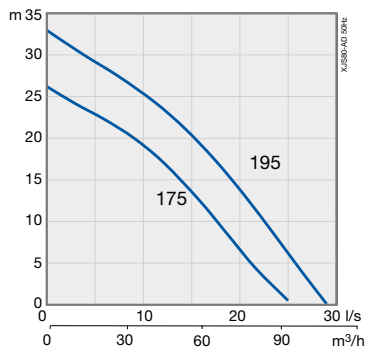

SUBMERSIBLE SLUDGE PUMP XJS 110

XJS 110 D* -170
XJS 110 D* -195

Motor rating P2	11.8 kW, 3~
Voltage (V)	230 / 400 / 500-550 / 690 / 1000
Full load (A)	37.4 / 21.5 / 17.2 / 12.5 / 8.6
Speed	2920 rpm
Free passage	48 x 60 mm
Discharge connections	Hose 2½", 3", 4" Thread G/BSP 2½", 3", 4"
Weight (excl. cable)	80 kg
Motor protection	Built-in
Electric cable	20 m

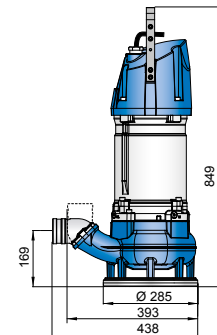
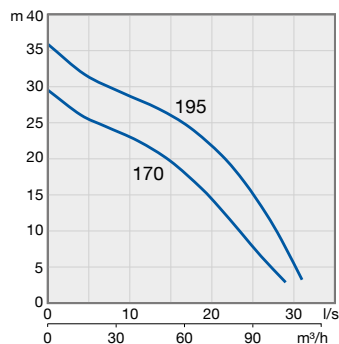

* Option: AquaTronic, built-in electronic pump control.

AquaTronic and Other Supervision Options

Submersible dewatering pumps XJ, XJC and XJS have several options for electronic supervision that make them even more reliable and easy to use. Most important is the AquaTronic unit, which ensures correct motor rotation every time.

AquaTronic

The AquaTronic unit replaces the built-in contactor in the basic pump configurations and ensures that the motor always rotates correctly, no matter how the phases are connected. Key benefits of the AquaTronic unit include:

- Correction of motor rotation if phases are improperly connected
- Run mode
- Integrated start equipment (direct or soft start depending on pump model)
- Motor protection against high temperature, high amperage and missing phase

If the pump is also equipped with an optional Level sensor, AquaTronic provides:

- Precise level control
- Protection against dry running

AquaTronic Service Diagnostic Program

Connecting a PC to the AquaTronic unit via USB cable provides access to the Service Diagnostic Program, which offers:

- Pump status data (temp, voltage, moisture, etc.)
- Pump operating history
- Pump failure history
- Pump service and maintenance history
- Digital manual and spare parts documentation

AquaPlug and AquaTronic Control Panel

AquaPlug and AquaTronic Control Panel are options that combine with AquaTronic to provide additional alarm and start/stop functions, as well as indications for important parameters. AquaPlug is incorporated into the power line via 16A or 32A sockets.

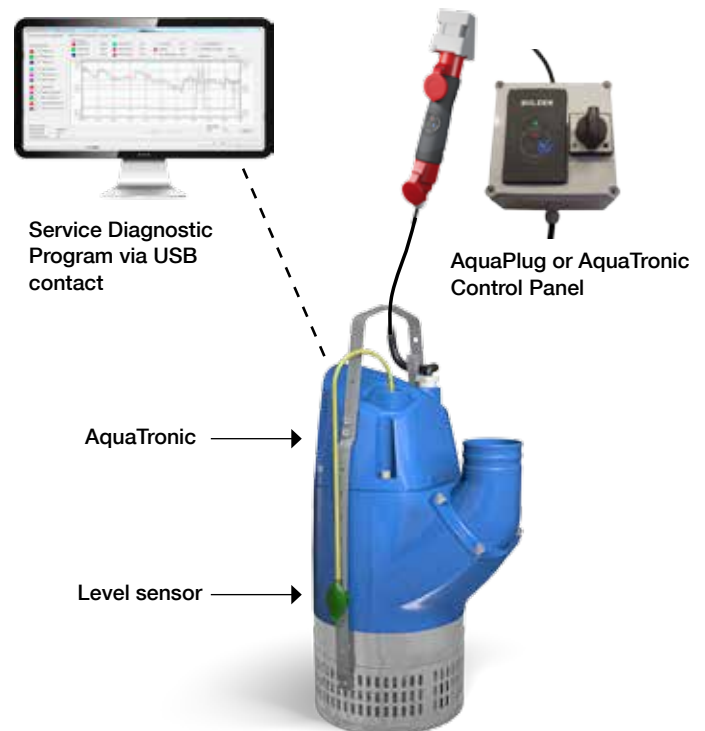

Overview of Electronic Supervision Features

The table below shows the range of features available when the AquaTronic unit and other electronic supervision options are used with the submersible dewatering pumps XJ, XJC and XJS.

Electronic supervision feature	Basic pump configuration with contactor	Pump with AquaTronic	Pump with AquaTronic + Level Sensor	Pump with AquaTronic + AquaPlug/ AquaTronic Control Panel	Pump with AquaTronic + AquaPlug/ AquaTronic Control Panel + Level Sensor
Run mode	✓	✓	✓	✓	✓
Integrated start equipment	✓	✓	✓	✓	✓
Automatic correction of rotation		✓	✓	✓	✓
Motor protection – high temp	✓	✓	✓	✓	✓
Motor protection – high amp		✓	✓	✓	✓
Protection against missing phase		✓	✓	✓	✓
Level control			✓		✓
Protection against dry running			✓		✓
Automatic restart			✓		✓
Stop mode				✓	✓
E-mode (automatic stop/run)					✓
Indication of water in oil				✓	✓
Indication of low motor insulation				✓	✓
Indication of high/ low voltage				✓ ✓	✓ ✓
Indication of high temp				✓ ✓	✓ ✓
Indication of high amp				✓ ✓	✓ ✓
Indication of phase imbalance				✓ ✓	✓ ✓
USB cable connection		✓	✓	✓	✓

✓ ✓ = Fault indication when pump is automatically stopped to protect the motor

Pump Options and Accessories

AQUATRONIC UNIT FOR CORRECT MOTOR ROTATION

Our built-in AquaTronic unit integrates electronic intelligence into the pump, ensuring correct motor rotation by automatically adjusting for incorrect phase order. It also protects the motor by stopping the pump in the event of over-amperage, overheating, low or high voltage or missing phase. Another feature of the AquaTronic unit is the internal software that allows pump performance and service diagnostics data to be viewed on a PC via USB link, enabling accurate evaluation of service and maintenance needs. The workshop manual and spare parts list, readily available in the AquaTronic unit, can be viewed via the link as well. The AquaTronic unit must be ordered when ordering the pump. Retrofitting is not possible.



AQUAPLUG AND AQUATRONIC CONTROL PANEL

AquaPlug and AquaTronic Control Panel are options that combine with AquaTronic to provide additional alarm and start/stop functions, as well as indications for important parameters. AquaPlug is incorporated into the power line via 16A or 32A sockets.



LEVEL SENSOR FOR PRECISE AND COST EFFECTIVE WATER LEVEL CONTROL

Together with AquaTronic, the level sensor provides precise and cost-effective water level control, and helps lower power consumption.



SOFTDRIVE FOR COST EFFECTIVE OPERATION

Sulzer offers a built-in SoftDrive concept on the J 205 pumps. It reduces starting current dramatically and provides smooth operation for both the power net and pump equipment. The pump can be started with a smaller-sized generator compared to a standard pump started directly on-line.



QUICK AND EASY INSTALLATION WITH FLOATATION RING

Sulzer offers a solution for pumps up to 45 kg. The ring is easy to install and can be used with dewatering pumps J 12-15, XJ 25-40.



FLOATATION SYSTEM TO PREVENT UNNECESSARY WEAR

A modular floatation system is available, covering pumps from 59 to 600 kg. The modular floatation system is easy to build and used with dewatering pumps XJ 50-110, XJS 50-110, J 205-604.



PROTECTIVE BELTS FOR MORE DURABLE OPERATION

Sulzer submersible dewatering pumps can easily be fitted with zinc anode belts providing protection against galvanic corrosion. The cast parts of the pump can also be protectively coated, ensuring trouble-free operation when pumping salty or brackish water.



POLYURETHANE FOR PROLONGED DRAINAGE PUMP LIFE

Sulzer offers wear rings in polyurethane, which increases resistance when pumping fine sand and other abrasive mediums. Polyurethane-coated wear rings are available as an option on J 205-604.

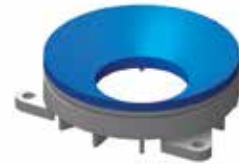

SERIES CONNECTIONS FOR PUMPING HIGH HEADS

With minimal effort, the standard Sulzer drainage pumps can be rebuilt to function in series for high head applications.



BOTTOM SUCTION ADAPTER FOR TOTAL WATER REMOVAL

On pumps J 12-15 and J 24, the standard bottom plate may be replaced by a bottom suction adapter. A basement floor or a tank can be pumped practically dry with this adapter.

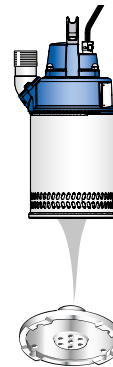

REPAIR KITS THAT SAVE TIME AND MONEY

Sulzer offers repair kits for all submersible dewatering pumps. The repair kits include common parts required for a typical repair. Our modular pump design makes it possible to repair all drainage and sludge pumps with just a few repair kits.



www.sulzer.com



E10361 en 2.2016 (3,000), Copyright © Sulzer Ltd 2016

This brochure is a general product presentation. It does not provide a warranty or guarantee of any kind. Please, contact us for a description of the warranties and guarantees offered with our products. Directions for use and safety will be given separately. All information herein is subject to change without notice.